

Installation & User Manual
For **CellCOM+**



Cellular Intercom System
Product Version 2.3.2



Contents

Overview of systemPg 3
Site SurveyPg 3
SIM cardPg 3
PowerPg3
Call Box OverviewPg 4
MountingPg 4
Inserting the SIM CardPg 4
Connections on GSM ControllerPg5
Keypad ConnectionsPg 5
Connecting to Gate controllerPg6
Other Wiring TipsPg 6
Powering UpPg 6
Programming GSM unitPg 7
GSM unit complete list of ParametersPg 9
Keypad OverviewPg 10
Basic Keypad ProgrammingPg 10
Full Keypad ProgrammingPg 10
Using the KeypadPg 12
Using the IntercomPg 12
Control by SMSPg 13
Check if Gate Open/ClosedPg 13
Using Optional AppPg 13
Setting up the App on iphonePg 14
Setting up the App on AndroidPg 15
MaintenancePg 15
TroubleshootingPg 16

Overview of System

Please read this entire manual before attempting to install this system.

This system should only be installed by a professional automatic gate installer or access control specialist dealer.

It is recommended that the system be set up, configured, commissioned and tested on a workshop bench **before** taken to site for installation.

Site Survey

Before installing this system, you need to be sure that there is good mobile GSM cell coverage in the area it is to be installed. It is recommended that you conduct a site survey, and check reception on the site for a GSM network. If reception is poor in the area, then this system is not recommended. This unit can operate on At&T and T-Mobile networks in the USA.

SIM Card

You will need a SIM card in order to use this system. It should be a regular voice and SMS text SIM card. Do not use a data only SIM, as this is only for tablets and will not work in the unit.

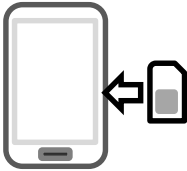

- 1) Ensure the SIM has calling credit, and can make and receive calls on a cell phone.
- 2) Check that the SIM is not locked to a phone and can be used in other devices. Call the service provider to unlock it if required.
- 3) Check that the SIM does not have a PIN code request.
- 4) You are now ready to begin programming.

Power

This system comes with a 15v d.c. power supply. It is recommended that it is located within 25 feet of the intercom and cabled in **14 gauge cable**.

Site Cabling

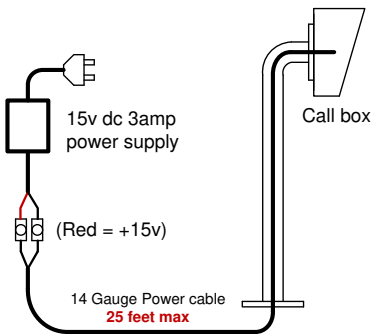

Inside Power Connection

Please note: If using 24v dc solar operator power, switch jumper below to 24v position **BEFORE** turning on power.

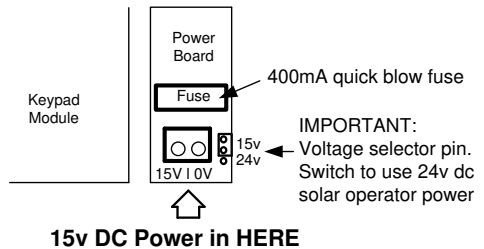

Note: The power board supplies filtered power to the keypad and cellular module, and has surge protection plus a fuse. In the event of a power surge or lightning surge, the fuse is designed to blow and help protect the equipment.

Call Box Overview

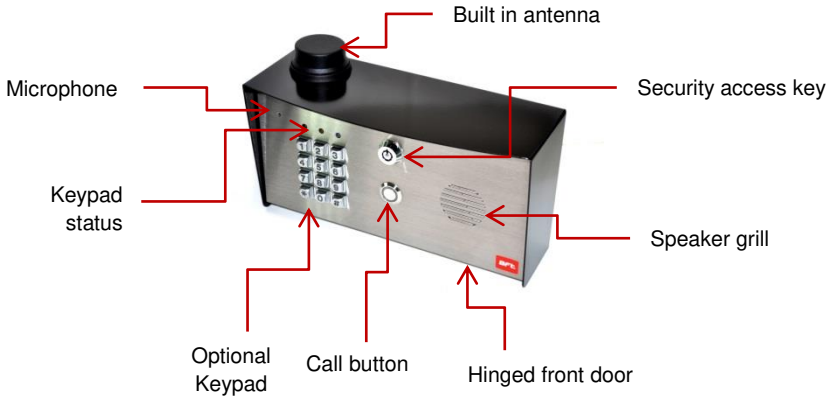

Tip: Keep all protective covers and films on the unit until fully installed. These covers are to protect the unit from scratches during installation.

Mounting

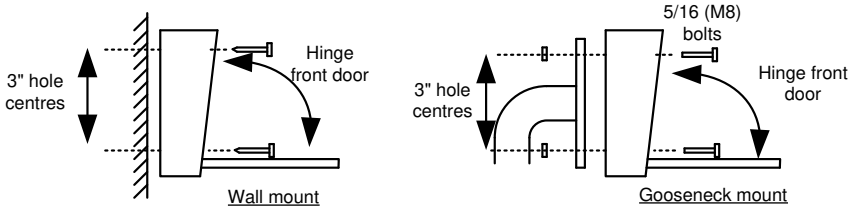

Inserting the SIM card

Note: This unit is a dual 2G/3G system, operating on either 2G or 3G network frequencies of 850/900/1800/1900MHz.



Please ensure the SIM card is a regular voice SIM card with SMS, from either At&T or T-Mobile. Do not use a data SIM as these are only for tablets.

- 1) Put the SIM into a phone to activate and register it with the network.
- 2) If you are using pay and go, top up the SIM with some airtime credit.
- 3) Test that the SIM can make and receive calls and can send and receive a SMS.
- 4) Ensure the power is OFF.
- 5) Slide the SIM card holder in the open direction, and carefully open the door. Do NOT force it.

Connections on the GSM Controller

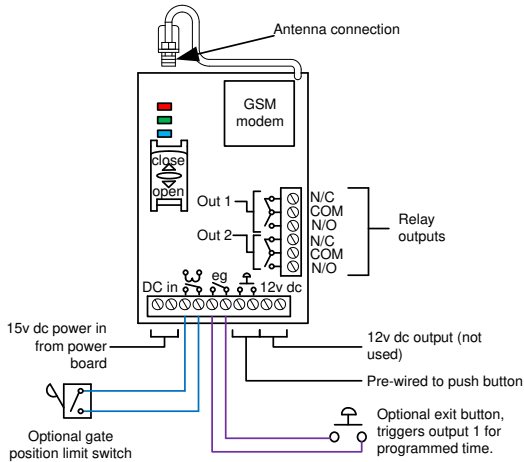

Code Lock Keypad connections (Keypad versions only)

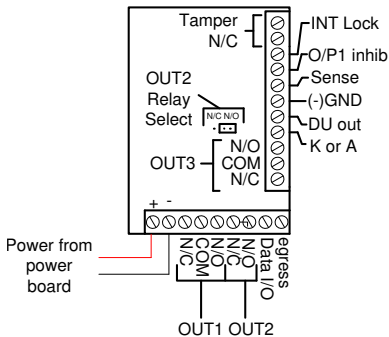

Commonly used connections

Outputs – This keypad has 3 outputs. All can be programmed for momentary and latching operation. For gate systems and AC strike locks, connect a keypad relay (normally open) in parallel with the GSM module relay. For magnetic locks, connect in series with normally closed contact.

Egress – This is for an optional exit button input, connected across this terminal and GND (-).

Advanced connections

INT Lock – Used to operate a door in conjunction with another keypad. 24v dc max voltage, 100mA sink.

O/P1 inhib – When closed, this disables all codes for relay group 1.

Sense – N/C connected to (-)GND, to be connected to N/C door contact. Can be used to generate door open or tamper alarm.

DU out – switches to (-) ground after the Duress Code is entered. Used to trigger alarm zone, or buzzer to notify guard. 100mA sink, 24VDC.

K or A – Not used.

DATA I/O PORT (Data Communication Bus) The Data I/O port is prepared for setting up a data bus for the connection of the auxiliary reader-keypads and the split-decoder in system expansion

Connecting to a Gate Controller

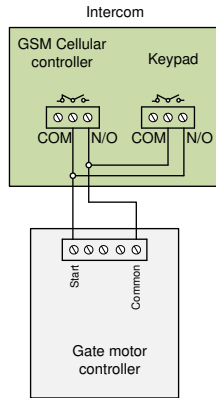

Alternative Keypad Wiring for Notification Feature

The CellCOM+ model has an additional feature which sends an SMS to a master user when the GSM unit triggers it's outputs. So if the user wants to know when the keypad is triggered, then wire a keypad output to egress input of the GSM as shown...

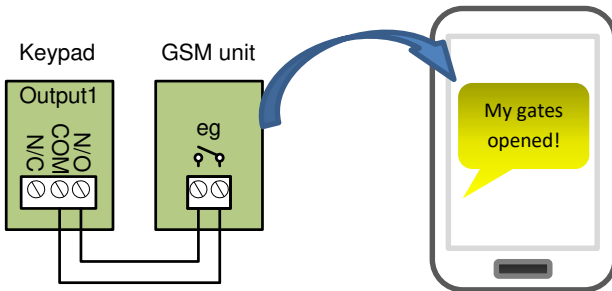

Powering Up

Perform a final check of wiring and ensure the antenna is connected before switching on the power. Once the power is switched on, the power LED should illuminate.

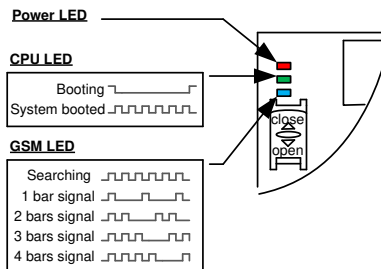

TIPS:

My GSM LED is still searching...

- Check the SIM card is registered and can make a call in a phone.
- Check the SIM card is seated correctly. Power off, clean the contacts on the SIM and the GSM unit, and reinsert.
- Check power cable distance and thickness.
- Increase antenna height & change network.
- Move antenna away from metal objects or overhanging shrubs.
- Fit a high gain antenna.

Programming

TIP: The GSM unit programming is by sending SMS text messages to the unit from a phone.

Step 1: Check Reception

Send the SMS ***20#** as shown, to the SIM card number of the intercom. The unit should reply with a reception level between 1 and 31.

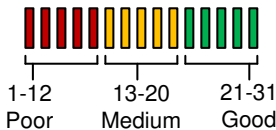

Note: Reception levels below 12 can give problems with the relay operation, and poor quality audio, or no audio coming from the microphone on the intercom (the person on the phone cannot hear anything), or buzz on the loud speaker.

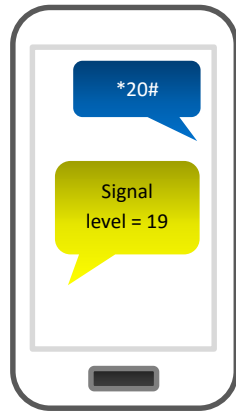

TIP: If reception levels are low, take action now! Either increase the height of the antenna to improve reception or request a higher gain antenna from your distributor or change to another network which may have better coverage.

Step 2: Programming dial out numbers

Programming text messages must start with a pass code string, followed by a command, followed by data, and each command is separated in the SMS by #.

To begin, program the unit to dial numbers when the call button is pressed. This module will dial up to 3 telephone numbers in sequence.

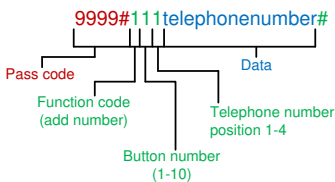

TIP...

- 111 = Telephone number 1.
- 112 = Telephone number 2.
- 113 = Telephone number 3.

The phone image shows an example of a number being stored and the reply sent by the unit to confirm OK. Up to 4 numbers can be sent in a single SMS. The pass code only needs entered at the beginning of each message, and then each new command string is separated by #.

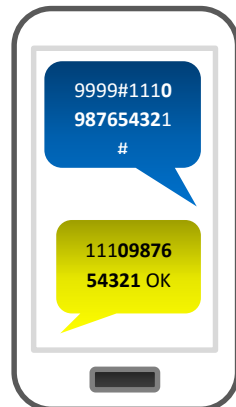

E.g. **9999#111firstnumber#112secondnumber#113thirdnumber#**

Step 3: Calling time

This is the time the unit will spend attempting to call a number before aborting the call and calling the next number on the list. It is very useful to adjust this time so that if there is voicemail or answer machine on a number, that the intercom aborts the call before the machine picks up, otherwise the unit will think the call is answered and never call the next number. To adjust this time, send the following SMS messages...

9999#45??# Ringing time for first phone number (Where ?? = time in seconds 10-99)

9999#46??# Ringing time for second phone number (Where ?? = time in seconds 10-99)

9999#47??# Ringing time for third phone number (Where ?? = time in seconds 10-99)

TIP: Remember to include the network connection time. A mobile phone needing to ring for 10 seconds may need a programmed ringing time of 15 seconds, because it can take 5 seconds to connect the call.

Step 4: Caller ID access control

This feature allows up to 100 numbers to be stored in memory. Any of these numbers can call the intercom. It will recognise the number, end the call without answering, and activate the output relay 1, all within a few seconds.

Tip: The intercom only compares the last 6 digits of the number with memory; therefore it is not necessary to enter country codes.

To add numbers, send the following SMS (up to 4 numbers can be entered in the same SMS)...

9999#72telephonenumber#72telephonenumber#72telephonenumber#72telephonenumber#

Tip: Even if a number is stored as a dialling out number when the call button is pressed, it needs stored again under the 72 feature if it is also required to have caller ID access.

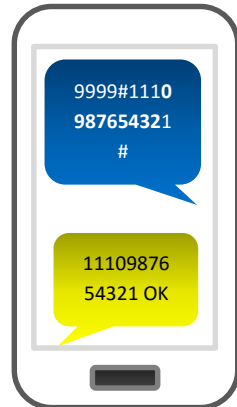

GSM unit complete list of parameters

The table below show the complete list of features in the cellular part of the intercom.

Programming messages below must begin with 9999# (assuming 9999 is still the programming passcode)...

Changing pass codes

01????#	Change programming password	9999
02????#	Change access control password (SMS control of relays, or non-stored numbers can call intercom & enter code to activate output 1).	1234
03????#	Change monitoring mode password (user can call the intercom, enter this pass code to listen in and speak)	5555

Dial out numbers

1XY????#	Store dialling out numbers. (X = button number 1-9 & 0 for button 10) (Y = number dialled 1-4) (???? = phone number)	N/A
1XY*#	Delete a dial out number. (X = button number) (Y = number position 1-4)	N/A

Volume controls

3?#	Speaker volume. Where ? = 1-9. 1 = lowest, 9 = highest.	5
4?#	Microphone volume. Where ? = 1-9. 1 = lowest, 9 = highest.	5

Timings

50?#	Relay 1 time. ? = seconds, 1-9999	1 sec
51?#	Relay 2 time. ? = seconds, 1-9999.	1 sec
45??#	Calling time for first number, adjust this to avoid voicemail picking up a call (10-99 secs)	20 secs
46??#	Calling time for second number, adjust this to avoid voicemail picking up a call (10-99 secs)	20 secs
47??#	Calling time for third number, adjust this to avoid voicemail picking up a call (10-99 secs)	20 secs
53????#	Talking time. 5-9999 seconds.	60 secs
55??#	Max monitoring time (for listen in mode when calling the intercom) 00-60 mins. 00 = no limit.	10 mins

Scheduled service calls

77number#	Store a service number to receive a scheduled call or SMS from the unit. Useful for SIM cards which are not often used to prevent switch off by the network provider.	N/A
57??#	Set the time schedule for the intercom to make a scheduled call or SMS to the service number. 00-60 day time schedule. 00 = no call or SMS.	00
58?#	Choose between making a scheduled call or scheduled SMS. 1 = SMS. 2 = call.	1
77*#	Delete the stored service number	N/A

Notification Number

78number#	Store a master user, who will receive a SMS notification from the intercom each time any of the output relays are triggered.	N/A
79text#	Where "text" is the content of the message to be sent. E.g. "Gates Opened, or Door Opened". This will be sent on closing of any output relay.	N/A
80?#	When ? = 1, this function is disabled. Set to 2 to enable.	N/A

Caller ID features

72number#	Store caller ID number. Max 14 digits. Only last 6 digits compared.	N/A
73number#	Delete caller ID number.	N/A
73*#	Delete all caller ID numbers	N/A

Service & diagnostic messages (no passcode required for these!)

*20#	Check reception level 1-31 (no passcode needed)	N/A
*21#	Check stored numbers. O = dial out number. I = dial in number. E = end of message. (no passcode needed)	N/A
*22#	Check input status and relay status. (No passcode needed)	N/A
*23#	Check the last 10 caller ID numbers which called the unit	N/A

Restore Defaults

999#	Send with passcode string to clear all programming.	N/A
------	---	-----

Keypad overview

Now that the GSM part of the intercom is programmed and working, you may now program the keypad. The keypad is programmed directly on the keys, not remotely by SMS.

This keypad has 3 outputs. The diagram below shows the LED indicators which indicate programming and relay status information.

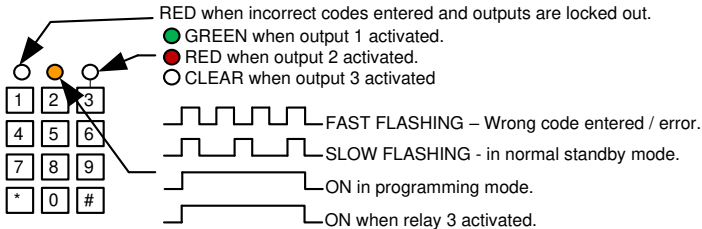

TIP: After power up, as a security precaution, the keypad cannot be programmed for 60 seconds. Once this time elapses, you may begin.

TIP: Flashing amber LED is normal standby mode!

Basic Keypad Programming

Quick start guide

1) Enter programming mode (amber LED should be ON)

0 0 0 0 * *

2) Enter a new user code...

1 0 2 0 0 0 ? ? ? ? #

3) Exit programming mode

* *

4) Enter the new user code to check the relay clicks.

Tip: The engineer code must be the same length as user codes. So if using a 6 digit engineer's code, then user codes must also be 6 digits long etc.

Full Keypad programming

Enter programming mode..



The unit is now in programming mode. Amber LED on the keypad should remain permanently on. 0000 is the default engineer's passcode.

Exit programming mode..



The unit should exit programming mode and the amber LED should start flashing again.

Enter or delete new user codes

There are 3 groups of user codes. Group 10 for relay 1, group 20 for relay 2, and group 30 for relay 3. The programming sequence is shown below...

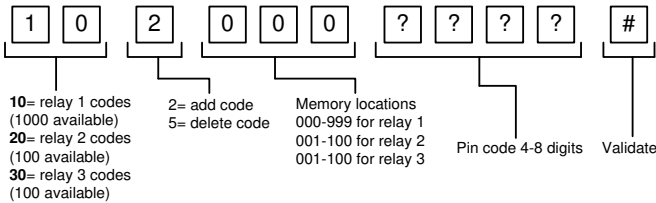

Example: Add user 31 to have access code 5555 operating relay 2...

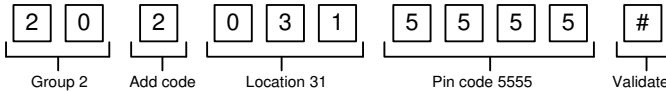

Enter a new ENGINEER / PROGRAMMER code...

Go into programming mode firstly then enter the following sequence...

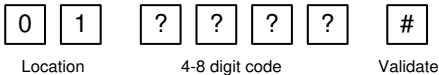

Replace ??? with your new ENGINEERS code. (Code length must be same as user code length).

Programming relay output times and modes...

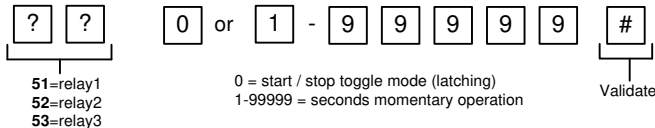

Delete a user code even if you don't know the code...

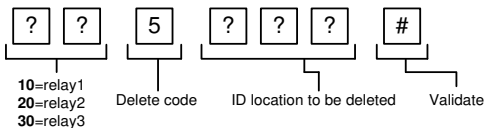

Delete an entire group of codes

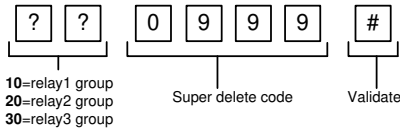

Programming super user codes...

A super user code can activate any of the 3 relays

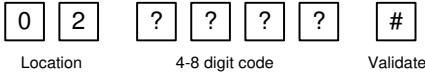

Restoring defaults

When in programming mode, you can enter the following sequence...

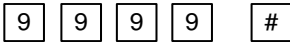

Note: This does NOT delete the ENGINEERS code.

When the ENGINEERS code is forgotten....

- 1) Wire a push button (or replicate with wire link) across the Egress terminal and (-)GND.
- 2) Switch off power for 1 minute.
- 3) Switch ON power.
- 4) during the first 60 seconds, press the EG button once to enable the function.
- 5) Enter the following code..

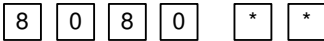

The keypad should now be in programming mode, ready to accept new data. Now change the Engineers code firstly.

Using the keypad

Using the standard codes...

Once you have exited out of programming mode, simply enter the user code.

Using super user codes

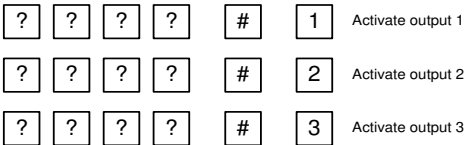

Using the intercom

This cellular intercom can dial up to 4 numbers in sequence for any call button when pressed..

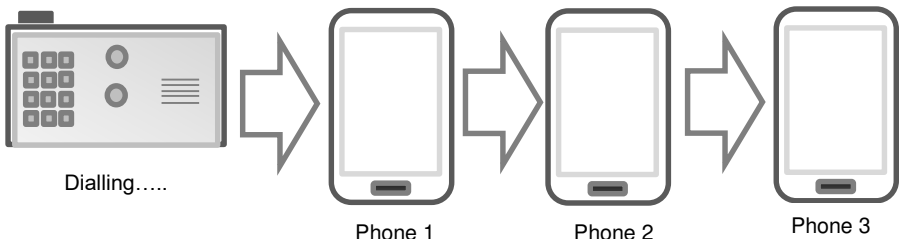

Any user receiving the call can answer, speak to the visitor, and press the following digits on their mobile or fixed line telepho~~ne~~to control the relay on the device...

Relay 1

Press **1** to trigger (use this mostly)
Press **2** to Latch or hold open
Press **3** to unlatch or close.

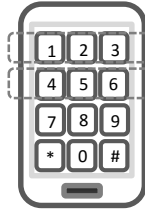

Relay 2

Press **4** to trigger
Press **5** to Latch or hold open
Press **6** to unlatch or close

Control by SMS

This intercom allows the user to send SMS commands to control the relays and check status as follows...

1234#**1**# - Relay 1 momentary trigger.
1234#**2**# - Relay 1 latch ON or hold ON.
1234#**3**# - Relay 1 unlatch or switch OFF.

1234#**4**# - Relay 2 momentary trigger.
1234#**5**# - Relay 2 latch ON or hold ON.
1234#**6**# - Relay 2 unlatch or switch OFF.

Check if door or gate is open or closed



Send the SMS as shown, and the unit will reply showing the status of the input limit switch (if used), and the relay..

This example shows that the input sensor is in OPEN state, and the relay is OFF.

If the relay is latched, then the status will change to ON.

If the input limit switch is closed, the status shown will change to CLOSED.

TIP: If there is not a physical limit switch fitted to the door or gate, then the status input will always show OPEN.

Using the Optional App

Android and Iphone users can download an optional app called **CELL BOX PLUS**.

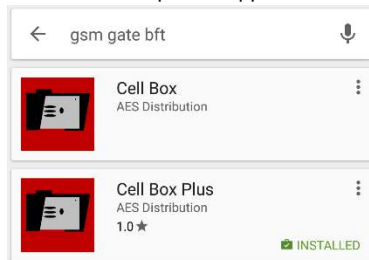

This app performs several functions to ease the use of the intercom..

Main Trigger button

Use this to speed dial intercom and momentary trigger the relay.

Latch Relay Button

Sends a pre-configured SMS to latch on the relay. Can be used to hold open gates or door.

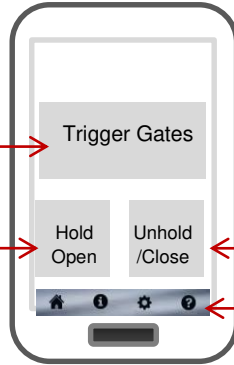

Un-Latch Relay Button

Sends a pre-configured SMS to unlatch the relay if it has previously been latched. Can be used to allow gates to close

Status features

Enter new screen to check signal strength, stored numbers, gate or door status.

The main function of the app is to speed dial the intercom when entrance 1 main trigger button is pressed, and if any other button is pressed, it will send a SMS, just like those shown in the "Control by SMS" section above. Before the app will work, the phone number of the SIM card in the unit needs entered in the app settings along with the SMS strings used to latch and unlatch relays.

Setting up the iphone APP

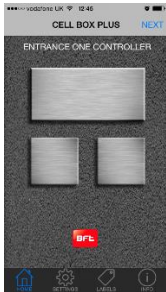

Home screen

Note labels show blank until names are entered. Note the NEXT button top right switches to entrance 2.



Settings

Use this screen to enter phone number of intercom and SMS messages. These can be copied from the SMS control section, and will be default strings unless the 1234 pass code has been changed.

E.g. hold open entrance 1 = 1234#2#



Labels

Use this screen to enter names for the buttons. For example Front Gate for entrance one, and Rear Gate for entrance 2 if needed. Once saved these will appear on the home screen.

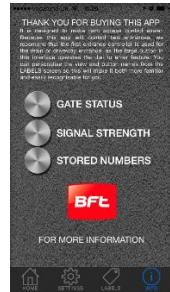

Info

Use this info screen to check gate position, relay status, reception, stored numbers etc.

Setting up the Android APP

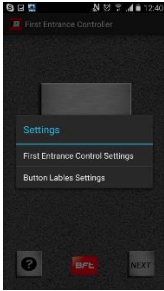

Home screen

Note Button labels show blank until names are entered. Press the MENU button on the android phone (bottom left) to go to settings! Note the NEXT button top right switches entrances.

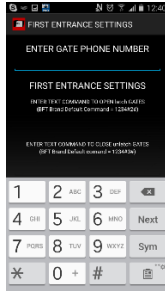

Entrance Settings

Use this screen to enter phone number of intercom and default SMS messages. These can be copied from the SMS control section, and will be default strings unless the 1234 pass code has been changed. E.g. hold open entrance 1 = 1234#1#

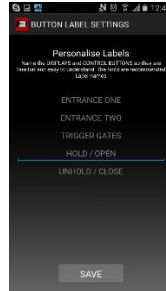

Button Labels

Use this screen to enter names for the buttons. For example Front Gate for entrance one, and Rear Gate for entrance 2 if needed. Once saved these will appear on the home screen.

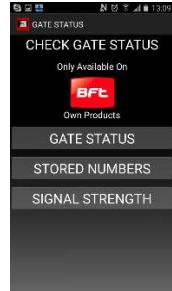

Check Status

Pressing the ? button on the home screen displays the options above where users can check status of gate position and other parameters.

Maintenance of the Intercom

The intercom SIM card will need topped up occasionally if it is a pre-pay casual SIM card. It is recommended that you register this SIM card on the provider's web site. You can register card payment details. Many networks offer an auto top up feature, which means they will automatically top up your intercom when the balance runs low. The stainless steel can dull or discolour over time in weather conditions. This can be polished with a suitable stainless steel cleaner.

Troubleshooting guide

Q. The unit will not power up. No LEDs on.

A. Check power supply voltage at intercom is within 14.8V DC. Cable length from PSU to intercom should be less than 25 feet and in 14 gauge. Check the fuse.

Q. The unit powers up but is not showing network reception or will not respond to SMS.

A. This means the unit is not able to detect the network for some reason.

-Power off the unit, remove the SIM and check it in a mobile phone to verify it can make a call and has calling credit.

-Disable any PIN code request if active on the SIM card.

-Check the SIM is a standard voice capable SIM. If you are unsure, contact your SIM card provider to verify. Compatible networks are At&T and T-Mobile.

-Check the reception is medium or good. Poor reception is not sufficient.

-Power off, remove the SIM, use fine sand paper to lightly sand the SIM pads and contacts on the GSM unit, lightly bend the contacts upwards so that they make better contact with the SIM and try again.

Q. The unit calls the first number, but there is not enough time to answer before it diverts to the next number.

A. Increase the no answer time as per programming instructions.

Q. The unit calls the first number but voicemail comes on before it can ring the second number.

A. Decrease the no answer time as per programming instructions.

Q. The caller ID part does not work.

A. Be sure to program the caller ID part under 72 feature. If your number is a private or number withheld, then it will not work.

-Even if you have already programmed a number to receive a call from the intercom, if you also want that number to have caller ID access, it must be programmed under the 72 feature also.

-Ensure the number is entered as you would normally dial it from another phone.

-For US customers, ensure the numbers have been entered with a leading 1. If this does not work, try again without the leading 1.

Q. There is no audio from the gate, but the person at the gate can hear ok.

A. This can be due to low reception or excessively long power cables.

-Check reception level by *20#.

-Change SIM card if necessary to another network which may have better coverage.

-Purchase a high gain antenna.

This may also be caused by a defective microphone, water on a microphone from a sprinkler for example, or dirt/insects blocking the microphone hole. If reception is optimum and the problem persists, contact your supplier or installer.

Q. The audio quality that can be heard on the remote telephone is poor or humming (buzzing).

A. A small amount of GSM buzz can be considered normal on GSM intercoms, but not so much that causes inability to hear the person speaking. This is a symptom of poor reception. Try above steps on checking and improving reception. Consider fitting an external high gain antenna.

Q. The keys do not work when the intercom calls a phone.

A. Check if you can hear the relay clicking at the gate when the keys are pressed during a call. If it can be heard, then the system is working, check wiring between the relay and the lock or gate panel. If the relays do not make a clicking sound, then check this feature on a different mobile cell phone or landline. If it works on a different phone, check the settings on the phone in question under DTMF tones.

Failure of DTMF tones to operate correctly is also a symptom of low reception or insufficient power cabling. Check steps above on improving reception or addressing the power problem.

-Also check that the relays are not already latched with the *22# command. If they are latched, they need unlatched before the trigger keys will work.

-Sometimes excessively long power cables or thin power cables can cause this problem. Prove it by connecting a temporary extension lead and the power supply directly to the unit.

Q. The keypad confirmation beeps when I enter my code but the gates or door lock does not open.

A. Check wiring. The keypad relay should be connected to the lock or gate system as well as the relay inside the GSM cellular part of the intercom.

- Do not wire power to the intercom in alarm cable or CAT 5 cable. It should be proper power cable and the power cable length should be as short as possible. Otherwise relays may not fire.

Q. The system was operating the gates fine, but now it will not trigger the gates.

99% of the time, this is caused by the user accidentally latching the relay. This latches the output relay permanently on. Send the intercom the following SMS *22#. The intercom should reply with a message detailing the relay status.. If it has been latched, then the message will state "the relay is ON". In this case refer to the user guide to read how to unlatch it again.

Q. The unit no longer calls out to phones but I can make a call to it from my phone.

A – Check there is balance on the SIM card.

A – Switch off the power, remove the SIM, put it into a phone, and check that a call can be made from a phone. This will verify if the SIM is still working and in service.

